

STAMP PLATING TYPE (Au-GOLD),
(Sn-TIN) OR (Ag-SILVER) IN THIS AREA

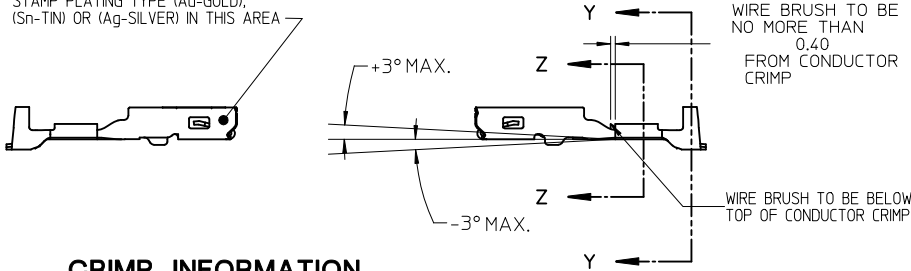

CRIMP INFORMATION
SEE TABLE 1 ON SHEET 2

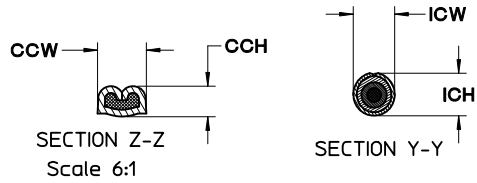

SILVER PLATING:
BASE LAYER:
ELECTRODEPOSITED DUCTILE SULFATE NICKEL
THICKNESS: 1.25 - 2.25 MICROMETERS

SILVER LAYER:
ZONE A1 AND ZONE A2
ELECTRODEPOSITED PURE SILVER (IMPURITIES 0.5% MAX)
FINISH: SEMI-BRIGHT
THICKNESS: 1.9 - 3.3 MICROMETERS

ANTI-TARNISH TREATMENT FOR SILVER PLATED TERMINALS:
EVABRITE WS

ZONE B:
TIN PLATING: PER MOLEX ES-88 REVISION: REL
THICKNESS 1 (1.25 - 2.25 MICROMETERS)
ELECTRODEPOSITED SULFAMATE DUCTILE NICKEL (BASE LAYER)

THICKNESS 2 (2.50 - 4.00 MICROMETERS) ELECTRODEPOSITED
TIN (100% TIN) MATTE FINISH

PLATING NOTES:

- TIN PLATING: (ENTIRE TERMINAL)
THICKNESS 1 (0.25-1.00 MICROMETERS)
ELECTRODEPOSITED ADVANCED TIN BARRIER (BASE LAYER)
THICKNESS 2 (0.50-1.00 MICROMETERS)
ELECTRODEPOSITED REFLOW TIN (100% TIN, NO BRIGHTENERS)

PLATING INFORMATION

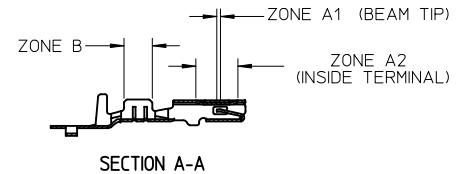

GOLD PLATING NOTES:

- ZONE A1 AND ZONE A2:
PER MOLEX ES-88 REVISION:REL
- THICKNESS 1 (1.25 - 2.25 MICROMETERS)
ELECTRODEPOSITED SULFAMATE DUCTILE NICKEL (BASE LAYER)
- THICKNESS 2 (0.76 MICROMETERS MINIMUM)
ELECTRODEPOSITED GOLD CAP
- ZONE B:
TIN PLATING: PER MOLEX ES-88 REVISION:REL
- THICKNESS 1 (1.25-2.25 MICROMETERS)
ELECTRODEPOSITED SULFAMATE DUCTILE NICKEL (BASE LAYER)
- THICKNESS 2 (2.50 - 4.00 MICROMETERS) ELECTRODEPOSITED
TIN (100% TIN) MATTE FINISH

NOTES: (UNLESS OTHERWISE SPECIFIED)

- MATING TERMINAL SHOWN ON MOLEX DRAWING SD-34080-001
- MATERIAL: ASTM B422, UNS C19025, HR04
THICKNESS: 0.30 mm +0.01
TEMPER: FULL HARD (REF)
TENSILE: 496 MIN MPA
PLATING: SEE PLATING NOTES
- MEETS PERFORMANCE SPECIFICATION FOR CABLE TO TERMINAL
ELECTRICAL CRIMPS PER SAE/USCAR-21 (8/2001)
- MEETS PERFORMANCE STANDARD FOR AUTOMOTIVE ELECTRICAL
CONNECTOR SYSTEMS FOR SAE/USCAR-2, REV. 4 (TEMP CLASS 3)
(4/2001)
- MEETS ELECTRICAL CONNECTION SYSTEM DESIGN SPECIFICATION
(SDS) REV.11 (5/2002)
- MEETS FIELD CORRELATED LIFE TEST (FCLT) PER
SAE/USCAR-20 (11/2001)
- INSERTION FORCE WITH INLINE BLADE
AVG FROM PV TESTING = 3.5 N TIN (REFERENCE)
3.1 N GOLD (REFERENCE)
- REFERENCE PK-31300-516 FOR REEL DIRECTION
- REFERENCE CS-34083-002 FOR ADDITIONAL
CRIMP INFORMATION

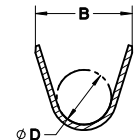

SECTION B-B
Scale 5:1

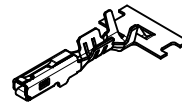
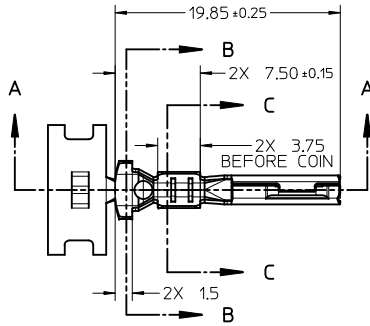

SCALE 2:1

SEE TABLE 2 ON SHEET 3
FOR CHARTED DIM.

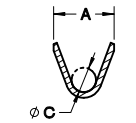

SECTION C-C
Scale 5:1

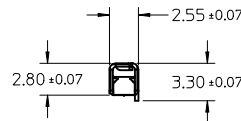
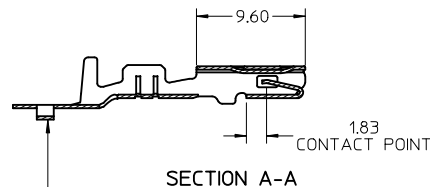

SECTION A-A

CARRIER BUMP DIRECTION
POINTS DOWN FOR TIN PLATED TERMINALS
POINTS UP FOR PRECIOUS PLATED TERMINALS

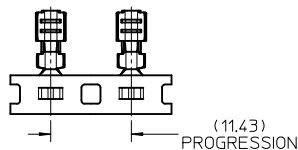

ENTER DESCRIPTION IEC NO: UAU2010-0419 DRW:KFERGUSON CHK:DA:DHIR APPR:BMOSER 2009/12/02 2009/12/02	QUALITY SYMBOLS ▽=0 ▽=0	GENERAL TOLERANCES (UNLESS SPECIFIED)		DIMENSION STYLE MM ONLY	SCALE 3:1	DESIGN UNITS METRIC	THIRD ANGLE PROJECTION	
		mm	INCH	DRAWN BY K.FERGUSON	DATE 4/14/2009	MX 150 RECEPTACLE CABLE SEAL		
		4 PLACES ± ---	± ---	CHECKED BY A. DHIR	DATE 4/14/2009			
		3 PLACES ± ---	± ---	APPROVED BY B. MOSER	DATE 4/14/2009	MOLEX INCORPORATED		
2 PLACES ± 0.10	± ---	MATERIAL NO. SEE TABLE	DOCUMENT NO. SD-34083-002	SHEET NO. 1 OF 3				
1 PLACE ± 0.3	± ---	DRAFT WHERE APPLICABLE MUST REMAIN WITHIN DIMENSIONS		SIZE C	THIS DRAWING CONTAINS INFORMATION THAT IS PROPRIETARY TO MOLEX INCORPORATED AND SHOULD NOT BE USED WITHOUT WRITTEN PERMISSION			
ANGULAR ± 3 °								

TABLE 1 – TERMINAL CRIMP DIMENSION REFERENCE TABLE

SUPPLIER PART NO.	PLATING	WIRE SIZE (awg)	WIRE SPECIFICATION	CONDUCTOR CCH (SEC Z-Z) ±0.05	CONDUCTOR CCW (SEC Z-Z) ±0.10	INSULATOR ICH (SEC Y-Y) ±0.10	INSULATOR ICW (SEC Y-Y) ±0.10	WIRE PULL FORCE (N)	OSR CABLE SEAL PART NO.	YAZAKI CABLE SEAL PART NO.	
RIGHT PAYOFF	LEFT PAYOFF										
34083-2001	34083-3001	TIN	14	MIL-123A	1.65	2.45	3.95	3.65	268	-	7158-3033-40
			14	MIL-135A1	1.65	2.45	3.80	3.65	268	E-1644-02	-
			16	MIL-123A	1.35	2.45	3.80	3.65	222	E-1644-02	-
34083-2002	34083-3002	TIN	18	MIL-123A	1.25	2.15	3.70	3.55	157	E-1644-00	-
			18	SAE J1128 (GXL)	1.25	2.15	3.90	3.55	157	E-1644-02	-
			20	MIL-123A	1.15	2.15	3.60	3.55	128	E-1644-00	-
			20	SAE J1128 (GXL)	1.15	2.15	3.80	3.55	128	E-1644-02	-
34083-2003	34083-3003	TIN	22	MIL-123A	1.00	1.60	3.50	3.45	88	E-1644-01	-
34083-2001	34083-3001	TIN	2.00mm ²	JASO D 611(AVSS)	1.60	2.45	3.95	3.65	268	-	7158-3033-40
34083-2001	34083-3001	TIN	1.50mm ²	MIL-126A1	1.40	2.45	3.80	3.65	257	E-1644-02	-
34083-2002	34083-3002	TIN	1.0mm ²	MIL-126A1	1.30	2.15	3.70	3.55	211	E-1644-00	-
34083-2002	34083-3002	TIN	0.75mm ²	MIL-126A1	1.25	2.15	3.60	3.55	142	E-1644-00	-
34083-2003	34083-3003	TIN	0.50mm ²	MIL-126A1	1.10	1.60	3.50	3.45	111	E-1644-01	-
34083-2003	34083-3003	TIN	0.50mm ²	JASO D 611(AVSS)	1.10	1.60	3.50	3.45	111	E-1644-01	-
34081-2003	34081-3003	GOLD	14	MIL-123A	1.65	2.45	3.95	3.65	268	-	7158-3033-40
			14	MIL-135A1	1.65	2.45	3.80	3.65	268	E-1644-02	-
			16	MIL-123A	1.35	2.45	3.80	3.65	222	E-1644-02	-
34081-2004	34081-3004	GOLD	18	MIL-123A	1.25	2.15	3.70	3.55	157	E-1644-00	-
			18	SAE J1128 (GXL)	1.25	2.15	3.90	3.55	157	E-1644-02	-
			20	MIL-123A	1.15	2.15	3.60	3.55	128	E-1644-00	-
			20	SAE J1128 (GXL)	1.15	2.15	3.80	3.55	128	E-1644-02	-
34081-2005	34081-3005	GOLD	22	MIL-123A	1.00	1.60	3.50	3.45	88	E-1644-01	-
34081-2003	34081-3003	GOLD	2.00mm ²	JASO D 611(AVSS)	1.60	2.45	3.95	3.65	268	-	7158-3033-40
34081-2003	34081-3003	GOLD	1.50mm ²	MIL-126A1	1.40	2.45	3.80	3.65	257	E-1644-02	-
34081-2004	34081-3004	GOLD	1.0mm ²	MIL-126A1	1.30	2.15	3.70	3.55	211	E-1644-00	-
			0.75mm ²	MIL-126A1	1.25	2.15	3.60	3.55	142	E-1644-00	-
			0.50mm ²	MIL-126A1	1.10	1.60	3.50	3.45	111	E-1644-01	-
34081-2005	34081-3005	GOLD	0.50mm ²	JASO D 611(AVSS)	1.10	1.60	3.50	3.45	111	E-1644-01	-
34081-4001	34081-5001	SILVER	14	MIL-123A	1.65	2.45	3.95	3.65	268	-	7158-3033-40
			14	MIL-135A1	1.65	2.45	3.80	3.65	268	E-1644-02	-
			16	MIL-123A	1.35	2.45	3.80	3.65	222	E-1644-02	-
34081-4002	34081-5002	SILVER	18	MIL-123A	1.25	2.15	3.70	3.55	157	E-1644-00	-
			18	SAE J1128 (GXL)	1.25	2.15	3.90	3.55	157	E-1644-02	-
			20	MIL-123A	1.15	2.15	3.60	3.55	128	E-1644-00	-
			20	SAE J1128 (GXL)	1.15	2.15	3.80	3.55	128	E-1644-02	-
34081-4003	34081-5003	SILVER	22	MIL-123A	1.00	1.60	3.50	3.45	88	E-1644-01	-
34081-4001	34081-5001	SILVER	2.00mm ²	JASO D 611(AVSS)	1.60	2.45	3.95	3.65	268	-	7158-3033-40
34081-4001	34081-5001	SILVER	1.50mm ²	MIL-126A1	1.40	2.45	3.80	3.65	257	E-1644-02	-
34081-4002	34081-5002	SILVER	1.0mm ²	MIL-126A1	1.30	2.15	3.70	3.55	211	E-1644-00	-
			0.75mm ²	MIL-126A1	1.25	2.15	3.60	3.55	142	E-1644-00	-
			0.50mm ²	MIL-126A1	1.10	1.60	3.50	3.45	111	E-1644-01	-
34081-4003	34081-5003	SILVER	0.50mm ²	JASO D 611(AVSS)	1.10	1.60	3.50	3.45	111	E-1644-01	-

ENTER DESCRIPTION IEC NO. UAU2010-0419 DRAWN BY K. FERGUSON CHECKED BY CHIKKA, DHIR APPROVED BY B. MOSER DATE 2009/12/02 REV 01	QUALITY SYMBOLS ▽=0 ▽=0	GENERAL TOLERANCES (UNLESS SPECIFIED): DIMENSION STYLE: MM ONLY		SCALE: METRIC	DESIGN UNITS: METRIC	THIRD ANGLE PROJECTION		
		4 PLACES ± 0.10 3 PLACES ± 0.15 2 PLACES ± 0.30 1 PLACE ± 0.50	INCH ± 0.005 ± 0.010 ± 0.020 ± 0.050	DRAWN BY: K. FERGUSON CHECKED BY: A. DHIR APPROVED BY: B. MOSER DATE: 4/14/2009	DATE: 4/14/2009	MX 150 RECEPTACLE CABLE SEAL		
		DRAFT WHERE APPLICABLE MUST REMAIN WITHIN DIMENSIONS		MATERIAL NO. SEE TABLE	DOCUMENT NO. SD-34083-002	MOLEX INCORPORATED		
		SIZE: D		THIS DRAWING CONTAINS INFORMATION THAT IS PROPRIETARY TO MOLEX INCORPORATED AND SHOULD NOT BE USED WITHOUT WRITTEN PERMISSION				

CRIMP TOOL INFORMATION
SEE TABLE 2 FOR TABLED DIMENSIONS

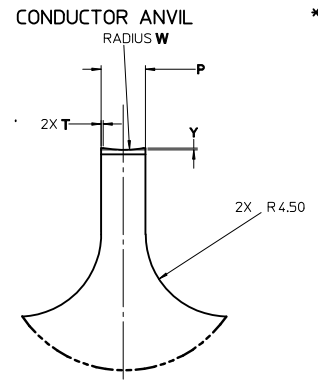
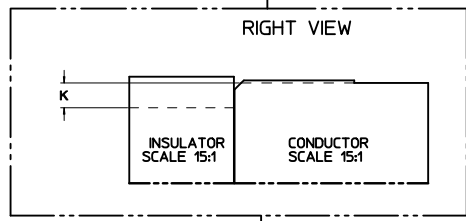
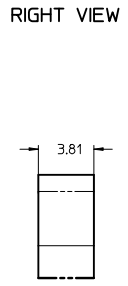
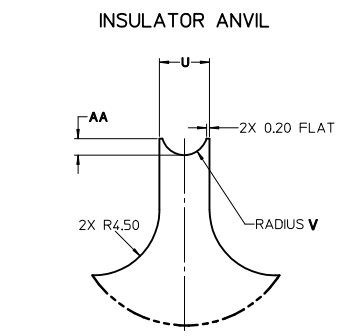
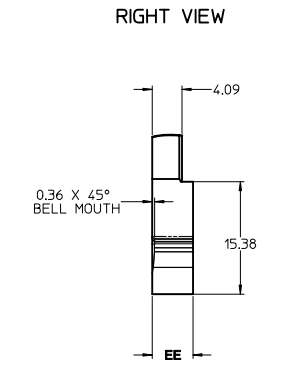
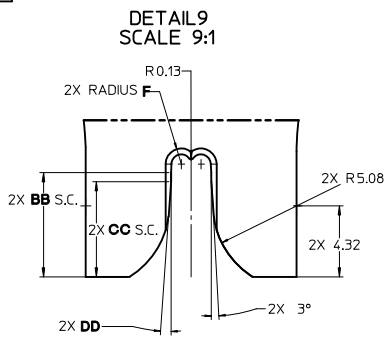
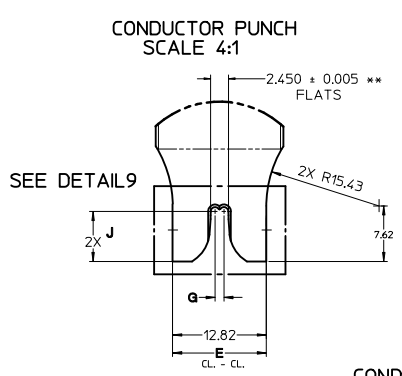
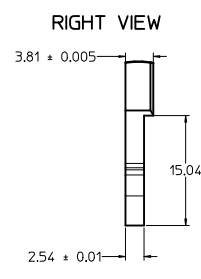
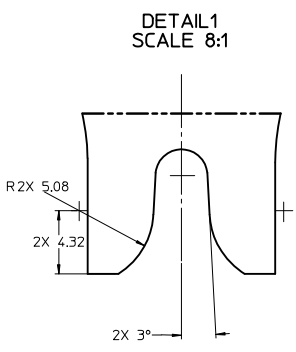
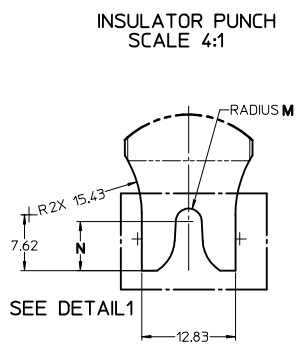

** 14-16 AWG, 150mm² & 2.0mm² ONLY

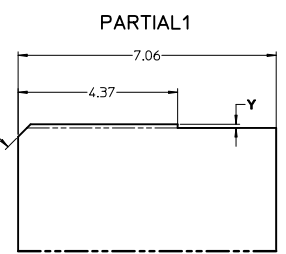

TABLE 2 - TERMINAL GRIP/CRIMP TOOL DIMENSION REFERENCE TABLE

SUPPLIER PART NUMBER		PLATING (STAMPING)	WIRE APPLICATION		A	B	C	D	E	F	G	J	K	M	N	P	T	U	V	W	Y	AA	BB	CC	DD	EE
RIGHT PAYOFF	LEFT PAYOFF		SAE (AWG)	METRIC (mm ²)	+0.3	+0.20	+0.3	+0.15	+0.01	+0.005	+0.005	+0.05	+0.01	+0.005	+0.10	+0.005	+0.03	+0.005	+0.005	+0.10	+0.01	+0.10	+0.01	+0.01	+0.01	±P
34083-2001	34083-3001	TIN	14	2.0	3.6	5.00	1.7	2.90	12.82	0.600	1.194	6.86	0.90	1.778	6.73	2.438	0.12	3.429	1.575	6.11	0.10	1.13	6.34	5.79	4°	5.59
			16	1.5	3.6	5.00	1.7	2.90	12.82	0.600	1.194	6.86	0.90	1.778	6.73	2.438	0.12	3.429	1.575	6.11	0.10	1.13	6.34	5.79	4°	5.59
34083-2002	34083-3002	TIN	18	1.0	3.3	5.00	1.3	2.90	12.57	0.556	0.963	7.34	0.70	1.753	6.73	2.085	0.33	3.378	1.699	1.94	0.14	0.88	-	-	-	3.81
			20	0.75	3.3	5.00	1.3	2.90	12.57	0.556	0.963	7.34	0.70	1.753	6.73	2.085	0.33	3.378	1.699	1.94	0.14	0.88	-	-	-	3.81
34083-2003	34083-3003	TIN	22	0.5	2.5	4.85	0.9	2.90	11.92	0.414	0.714	6.27	0.55	1.737	7.06	1.576	0.26	3.327	1.524	2.00	0.07	1.08	-	-	-	3.81
34081-2003	34081-3003	GOLD	14	2.0	3.6	5.00	1.7	2.90	12.82	0.600	1.194	6.86	0.90	1.778	6.73	2.438	0.12	3.429	1.575	6.11	0.10	1.13	6.34	5.79	4°	5.59
			16	1.5	3.6	5.00	1.7	2.90	12.82	0.600	1.194	6.86	0.90	1.778	6.73	2.438	0.12	3.429	1.575	6.11	0.10	1.13	6.34	5.79	4°	5.59
34081-2004	34081-3004	GOLD	18	1.0	3.3	5.00	1.3	2.90	12.57	0.556	0.963	7.34	0.70	1.753	6.73	2.085	0.33	3.378	1.699	1.94	0.14	0.88	-	-	-	3.81
			20	0.75	3.3	5.00	1.3	2.90	12.57	0.556	0.963	7.34	0.70	1.753	6.73	2.085	0.33	3.378	1.699	1.94	0.14	0.88	-	-	-	3.81
34081-2005	34081-3005	GOLD	22	0.5	2.5	4.85	0.9	2.90	11.92	0.414	0.714	6.27	0.55	1.737	7.06	1.576	0.26	3.327	1.524	2.00	0.07	1.08	-	-	-	3.81
			14	2.0	3.6	5.00	1.7	2.90	12.82	0.600	1.194	6.86	0.90	1.778	6.73	2.438	0.12	3.429	1.575	6.11	0.10	1.13	6.34	5.79	4°	5.59
34081-4001	34081-5001	SILVER	16	1.5	3.6	5.00	1.7	2.90	12.82	0.600	1.194	6.86	0.90	1.778	6.73	2.438	0.12	3.429	1.575	6.11	0.10	1.13	6.34	5.79	4°	5.59
			18	1.0	3.3	5.00	1.3	2.90	12.57	0.556	0.963	7.34	0.70	1.753	6.73	2.085	0.33	3.378	1.699	1.94	0.14	0.88	-	-	-	3.81
34081-4002	34081-5002	SILVER	20	0.75	3.3	5.00	1.3	2.90	12.57	0.556	0.963	7.34	0.70	1.753	6.73	2.085	0.33	3.378	1.699	1.94	0.14	0.88	-	-	-	3.81
			22	0.5	2.5	4.85	0.9	2.90	11.92	0.414	0.714	6.27	0.55	1.737	7.06	1.576	0.26	3.327	1.524	2.00	0.07	1.08	-	-	-	3.81

ENTER DESCRIPTION EC NO. 141/2010-04-9 DR. DWAN FERGUSON 2009/12/02 CHK'D BY A. DHIR 2009/04/15 APPR'D BY B. MOSELER 2009/04/15 A5	QUALITY SYMBOLS 0 1	GENERAL TOLERANCES (UNLESS SPECIFIED) mm INCH 4 PLACES ± --- ± --- 3 PLACES ± --- ± --- 2 PLACES ± 0.10 ± --- 1 PLACE ± 0.3 ± --- ANGULAR ± 3°	DIMENSION STYLE MM ONLY SCALE 1:1 DESIGN UNITS METRIC THIRD ANGLE PROJECTION	DRAWN BY DATE K. FERGUSON 4/14/2009 CHECKED BY DATE A. DHIR 4/14/2009 APPROVED BY DATE B. MOSELER 4/14/2009	TITLE MX 150 RECEPTACLE CABLE SEAL
	MATERIAL NO. SEE TABLE	DOCUMENT NO. SD-34083-002	SHEET NO. 3 OF 3	Molex MOLEX INCORPORATED	THIS DRAWING CONTAINS INFORMATION THAT IS PROPRIETARY TO MOLEX INCORPORATED AND SHOULD NOT BE USED WITHOUT WRITTEN PERMISSION
	DRAFT WHERE APPLICABLE MUST REMAIN WITHIN DIMENSIONS	SIZE	SEE TABLE	SEE TABLE	SEE TABLE
	SEE TABLE	SEE TABLE	SEE TABLE	SEE TABLE	SEE TABLE
	SEE TABLE	SEE TABLE	SEE TABLE	SEE TABLE	SEE TABLE